

# NAPOLY

240 cm



## SZERELÉSI ÚTMUTATÓ

## Gardrób csomag tartalma:

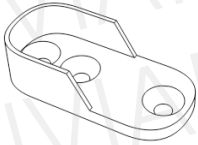

rúdtárcsa 4db



3,5x16 csavar 8db

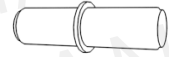

polctartó 8db

(A csomagok több alkatrész tartalmazhatnak, mint amennyire szüksége van!)

## Szükséges szerszámok:

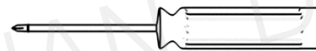

**Ne egyedül végezze az összeállítást!**

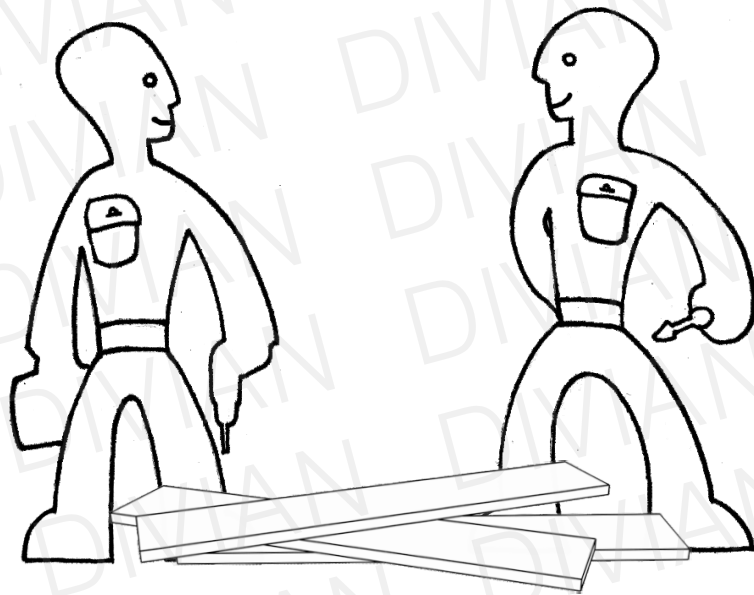

**Óvja az elemeket a sérülésektől!**

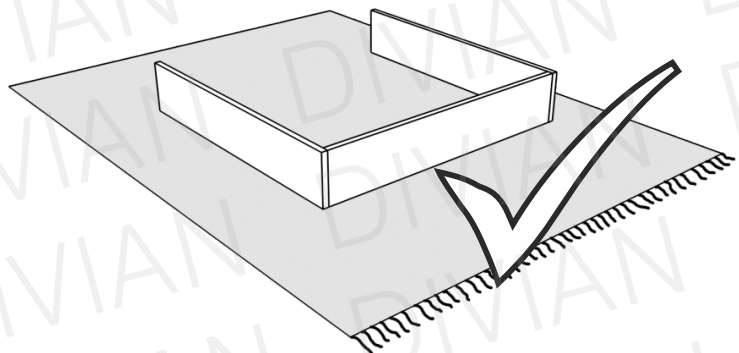
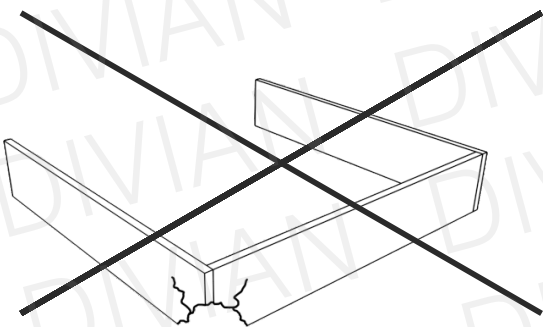

# ELEMEK

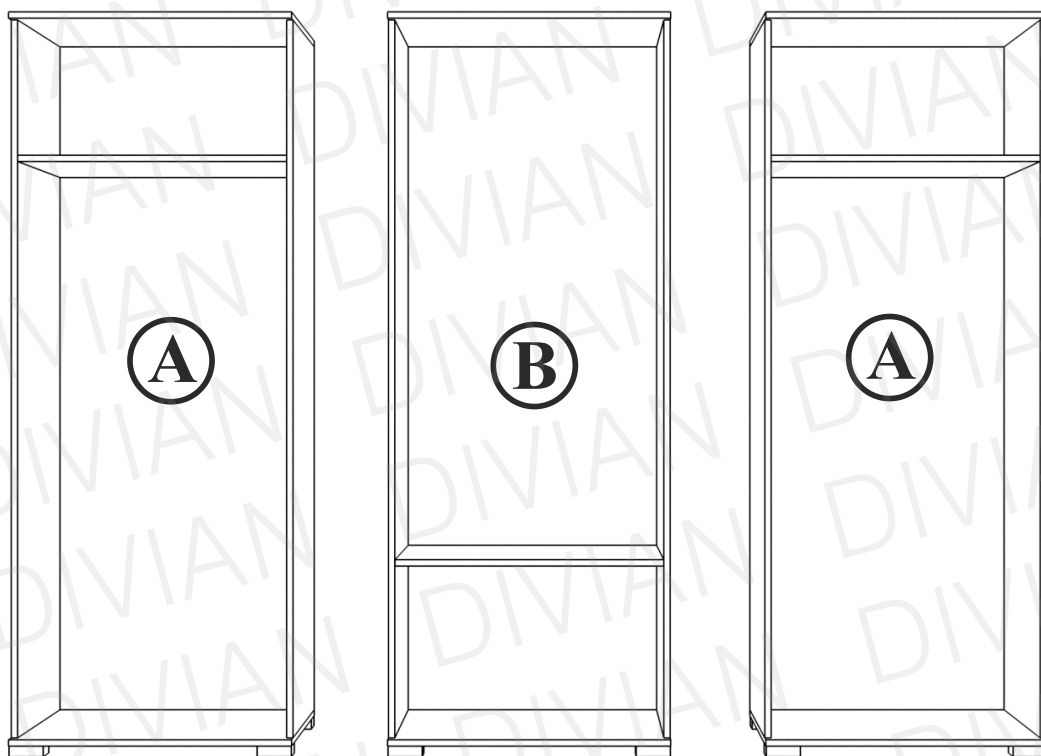

A könnyebb áttekinthetőség érdekében a szerelési útmutatóban az adott elemeket ajtók nélkül ábrázoljuk. Az összeszereléshez Önnek természetesen nem szükséges levennie az ajtókat!

**1**

4x



8x



Végezzék el a lépést mindkét A elemnél.

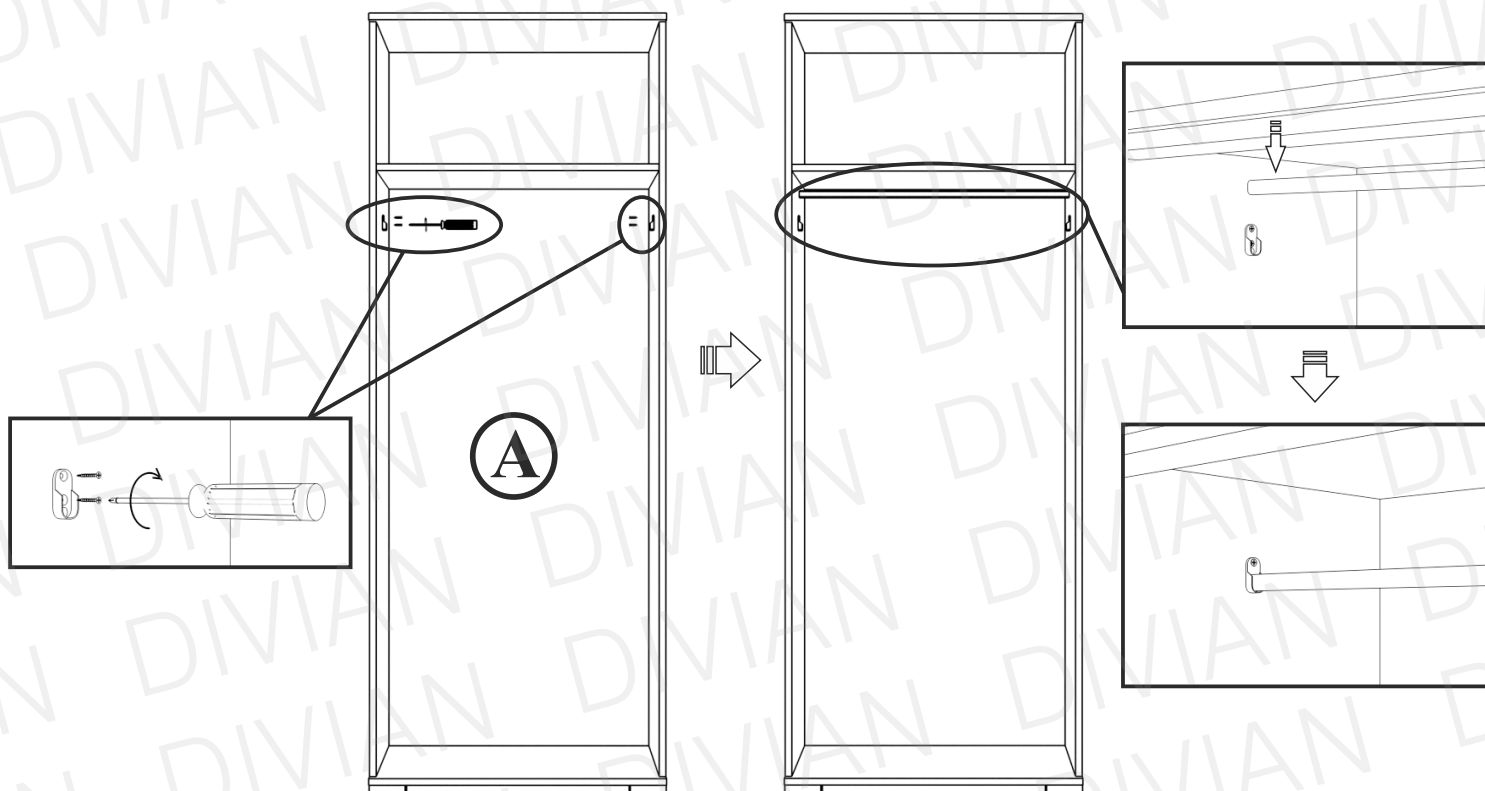

2

8x

